

## FEATURES

- Epitaxial planar die construction.
- Complementary PNP type available: MMBT4403.
- Ideal for medium power amplification and switching.

## APPLICATIONS

- General purpose application, switching application.

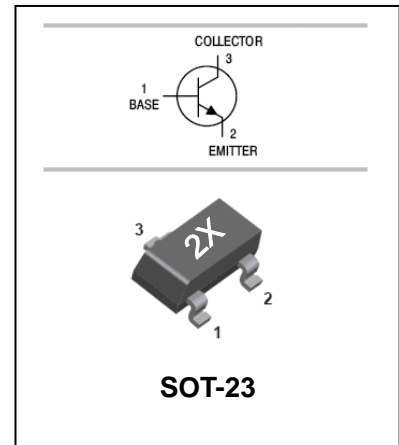

## MAXIMUM RATING @ Ta=25°C unless otherwise specified

Symbol	Parameter	Value	Units
V <sub>CB0</sub>	Collector-Base Voltage	60	V
V <sub>CEO</sub>	Collector-Emitter Voltage	40	V
V <sub>EBO</sub>	Emitter-Base Voltage	6	V
I <sub>C</sub>	Collector Current -Continuous	600	mA
P <sub>C</sub>	Collector Power Dissipation	350	mW
T <sub>J</sub> , T <sub>stg</sub>	Junction and Storage Temperature	-55~150	°C

**ELECTRICAL CHARACTERISTICS @ Ta=25°C unless otherwise specified**

Parameter	Symbol	Test conditions	MIN	TYP	MAX	UNIT
Collector-base breakdown voltage	$V_{(BR)CBO}$	$I_C=100\mu A, I_E=0$	60			V
Collector-emitter breakdown voltage	$V_{(BR)CEO}$	$I_C=1mA, I_B=0$	40			V
Emitter-base breakdown voltage	$V_{(BR)EBO}$	$I_E=100\mu A, I_C=0$	6			V
Collector cut-off current	$I_{CBO}$	$V_{CB}=50V, I_E=0$			0.1	$\mu A$
Collector cut-off current	$I_{CEO}$	$V_{CE}=35V, I_E=0$			0.1	$\mu A$
Emitter cut-off current	$I_{EBO}$	$V_{EB}=5V, I_C=0$			0.1	$\mu A$
DC current gain	$h_{FE}$	$V_{CE}=1V, I_C=0.1mA$	20			
		$V_{CE}=1V, I_C=1.0mA$	40			
		$V_{CE}=1V, I_C=10mA$	80			
		$V_{CE}=1V, I_C=150mA$	100		300	
		$V_{CE}=2V, I_C=500mA$	40			
Collector-emitter saturation voltage	$V_{CE(sat)}$	$I_C=150mA, I_B=15mA$ $I_C=500mA, I_B=50mA$			0.4 0.75	V
Base-emitter saturation voltage	$V_{BE(sat)}$	$I_C=150mA, I_B=15mA$ $I_C=500mA, I_B=50mA$		0.75	0.95 1.2	V
Transition frequency	$f_T$	$V_{CE}=10V, I_C=20mA$ $f=100MHz$	250			MHz
Collector output capacitance	$C_{ob}$	$V_{CB}=5V, I_E=0, f=1MHz$			6.5	pF

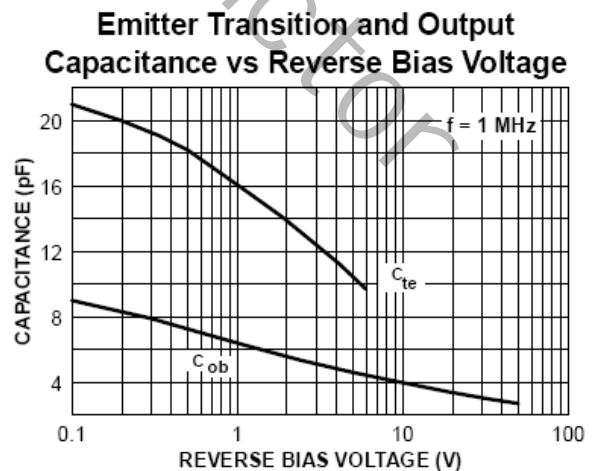
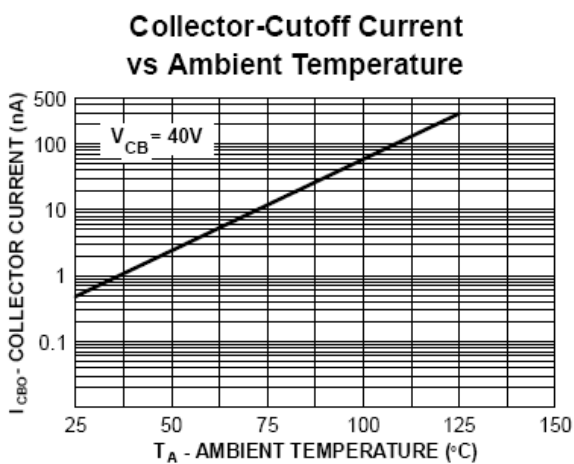
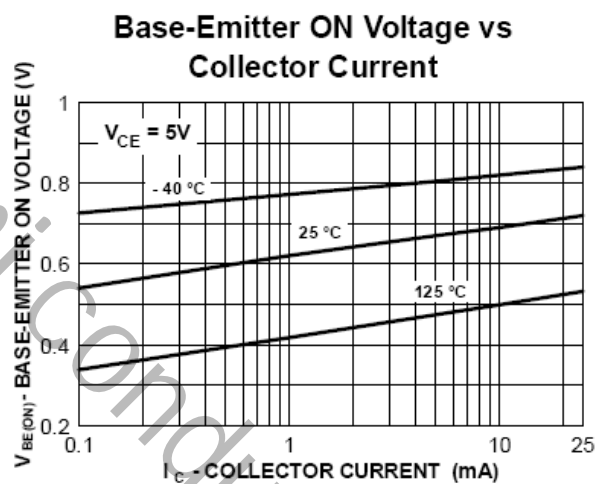
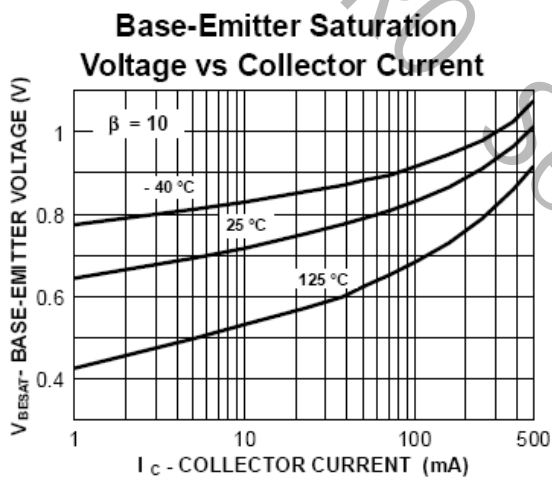
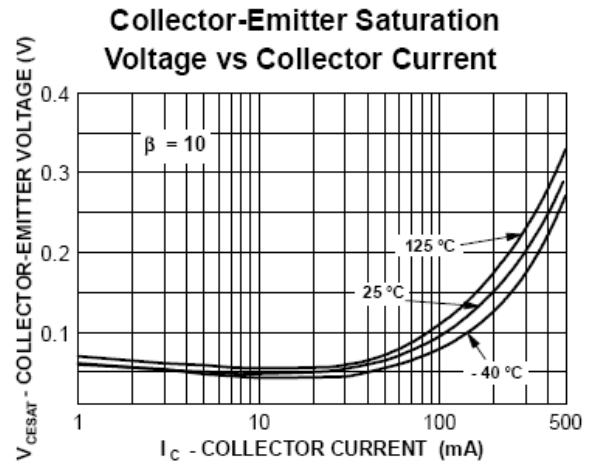
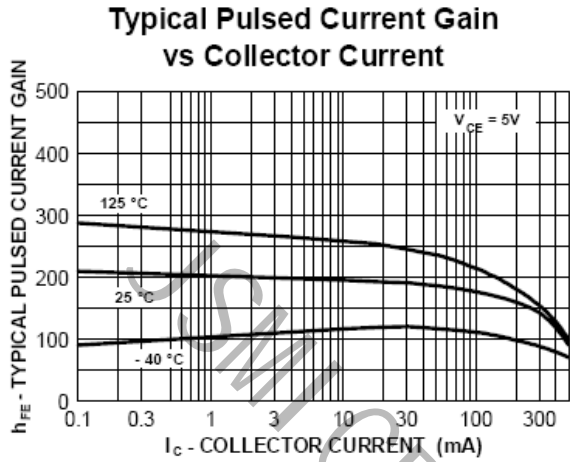
**TYPICAL CHARACTERISTICS @  $T_a=25^\circ\text{C}$  unless otherwise specified**

## PACKAGE OUTLINE

Plastic surface mounted package

SOT-23

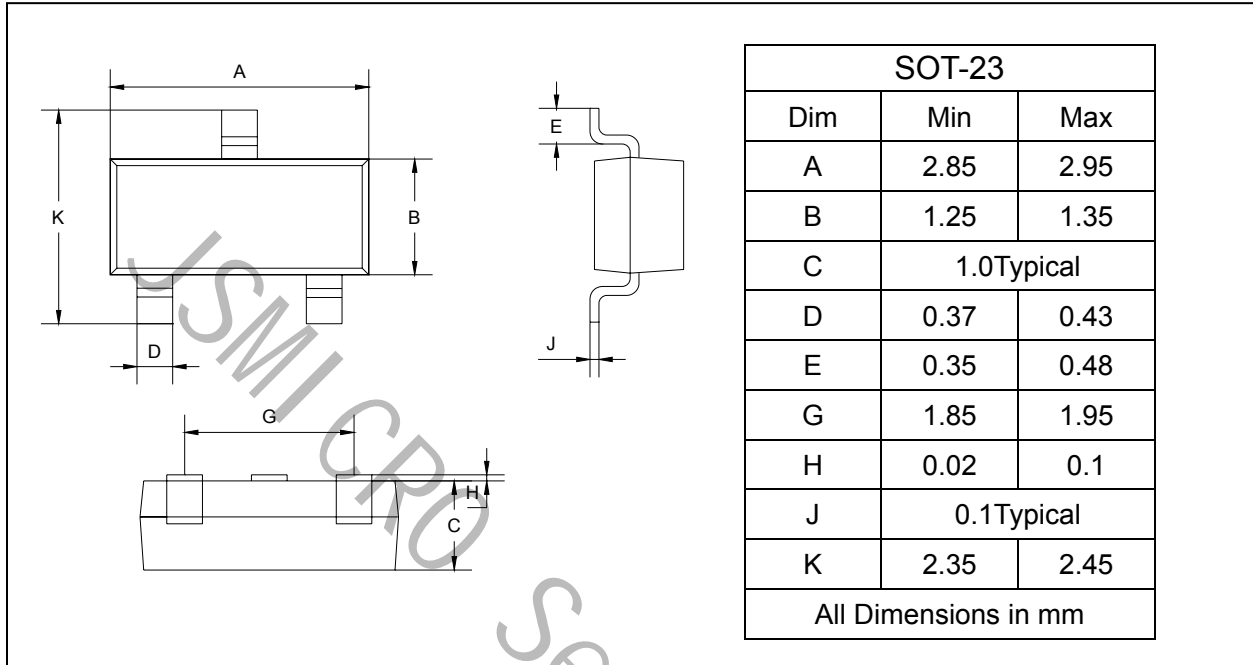

## SOLDERING FOOTPRINT

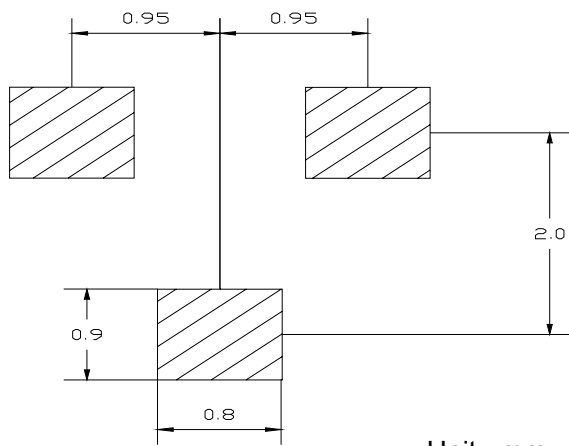

## PACKAGE INFORMATION

Device	Package	Shipping
MMBT4401	SOT-23	3000/Tape&Reel